

Genealogy of William Arthur Blaylock

son of
Samuel Patrick Blaylock
and Mary Elizabeth Canter Blaylock

husband of
Anna Maude Blaylock
who is the daughter of
Joseph M. Blaylock
and Barbra Ellen Felty

Favorite activities: gardening -- Arthur hauled dirt by the wheelbarrowful from the hill behind the house to the front yard to make a level yard.

Favorite drink: Orange Crush

Reputation: strong, hard worker with a bad temper. Arthur built his retirement home using whatever was handy. When the house was remodeled 30 or more years after Arthur's death, it was discovered that wall studs were young trees with branches and rebar in concrete steps included an old rifle.

Medical history: Arthur had a stroke when he was approximately in his 50s. He had a full recovery except for a slight pull at the corner of his mouth. Arthur died of old age.

The best way to view this family tree -- which is in genogram format -- is to go to the bottom of the file and scroll up -- the way a tree grows.

Primary researchers, Gail Blaylock Garrett and Judy Blaylock Kilpatrick, make every effort to verify data through as many sources as possible. Click on blue hyperlinks to view documents or additional information or photographs.

Unless a document is attached for verification, information is based upon interview and oral or written history.

Many people left Germany, especially from the Palatine area, in the early to mid-1700s. Johan Michael Braun was one. He was born Jan 15, 1724 and according to Rupp's "Thirty Thousand Immigrants", he arrived at Philadelphia, Pennsylvania on Sept. 26, 1737. He had sailed on the ship, "Saint Andrew Galley". John Stedham, Master.

He settled in East Hanover, Lebanon Twp, Lancaster Co, Pennsylvania. (Later Dauphin Co, and now Lebanon Co.) He met Anna Margaret Karger who lived in the town of Warwick, also in Lancaster Co. They were married on Jan 26, 1746 in the Hill Evangelical Lutheran Church by Reverend John Casper Stoever.

Michael and Anna farmed in East Hanover. They had a mill on their property that was erected at Sahara Creek and Michael was a blacksmith.

Michael died in Lebanon Twp, Lancaster Co, Pennsylvania and he was buried in Bindagle's Church Cemetery north of Palmyra with the following inscription on his tombstone: Michael Brown b. 5 Jan, 1724 d. 13 Mar, 1785 2nd Lt., 8th Co, 6th Batt, Lancaster Co Militia (Revolutionary War)

(Source: "Der Braun Volks" by Leila Smith Balis, copyright May, 1991)

John Michael Braun

Anna Juliana Karger

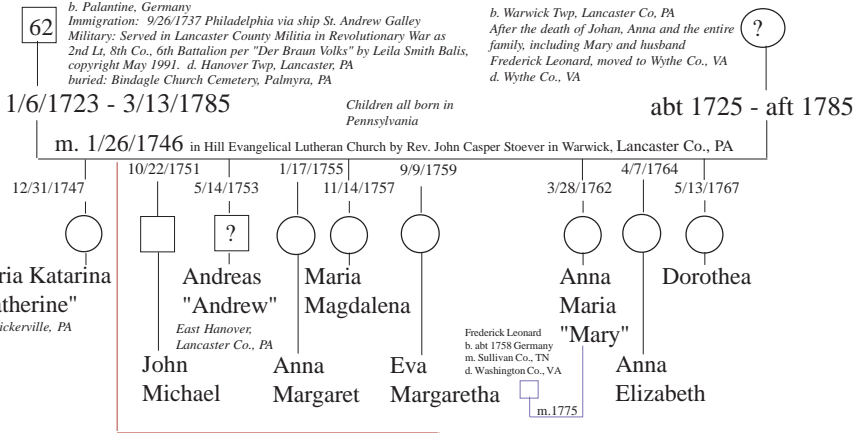

According to a biography of Rev. James A. Brown (son of Christopher Brown and Anna Maria Rader), the entire family of Johan Michael Brown, married sons, married daughters, single daughters and their families all moved from Hanover Township, Lancaster County, Pennsylvania to Montgomery County, VA (now Wythe Co.) in 1785. The families of Andrew Brown, Christopher Brown, Michael Brown, Nicholas Cassell (wife Margaret Brown) and Frederick Leonard (wife Mary Brown) settled in an area that would become the community of St. Johns Lutheran Church.

Thomas Truman Canter

Elizabeth Hickey

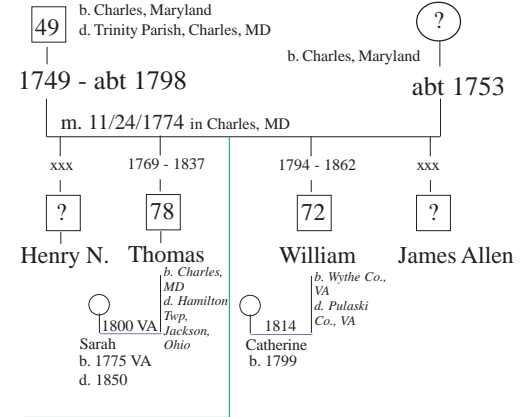

William Lewis

Jane Griffith

Anne Montgomery

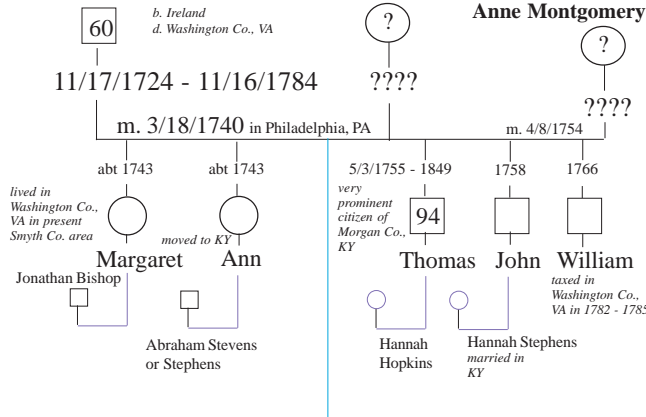

Christopher Braun

Maria Mason

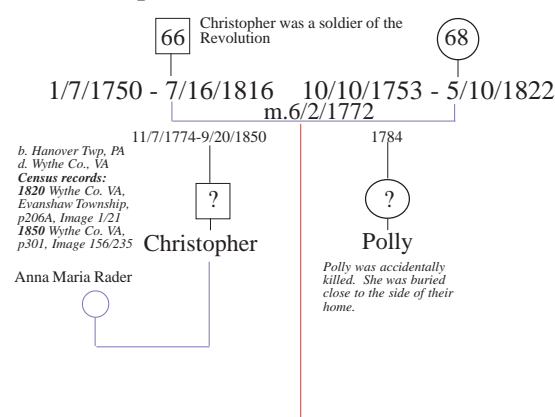

Daniel Held (Helt)

Unknown

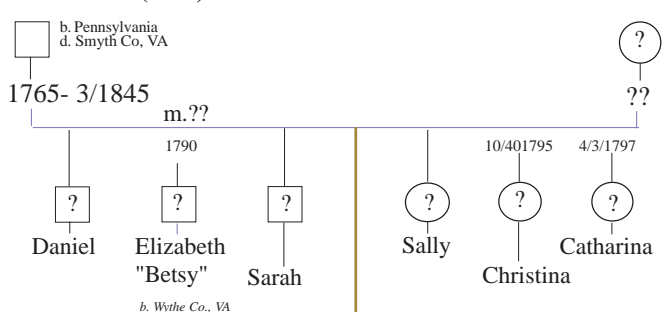

Michael Brown

Barbara Knipp

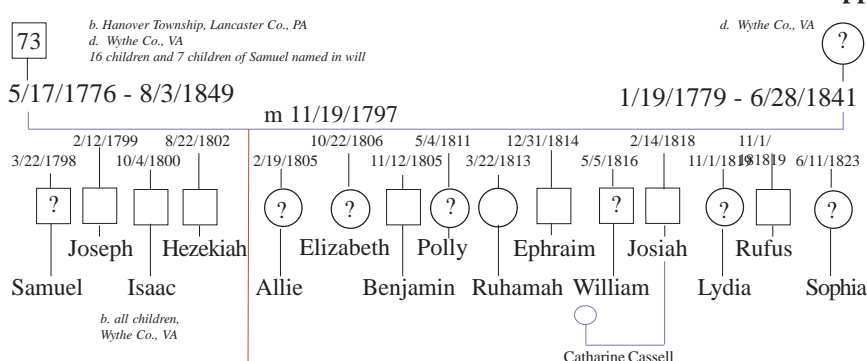

Generation 7

Generation 6

Generation 5

Joseph was born at sea, and both parents died while at sea. Joseph was taken by friends to NC where he was bound out. When the Revolutionary War started he joined the army and was made a courier. Later he was made a special courier to Gen. George Washington.

Joseph Whittaker **Obedience "Biddie" Purdue**

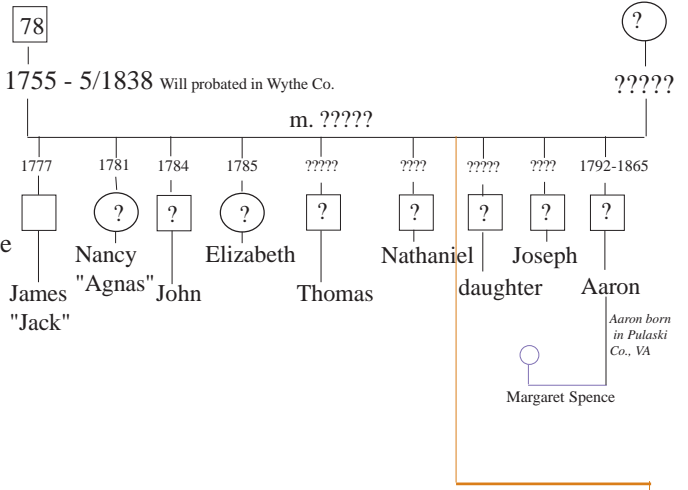

Griffith "Grifey" R. Lewis

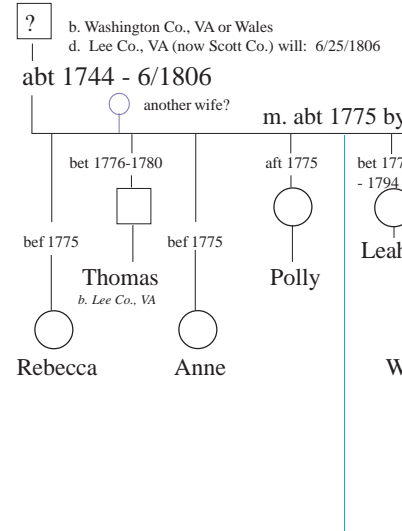

Mary Brown

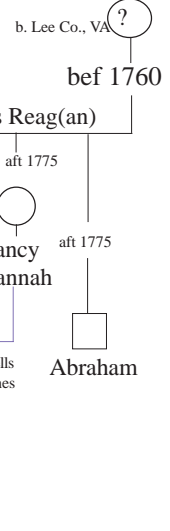

Truman Canter

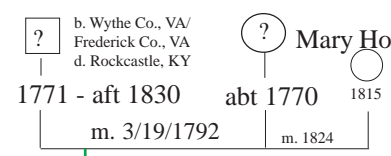

Canter, (Carter) Truman and Cynthia Harris, dau. John, Mar. 19, 1792. Sur. Samuel Harris.--Franklin Co., VA Marriage Bonds 1786-1858, Pg 54

Levi Canter

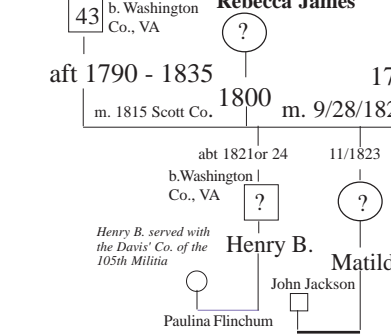

Henry B. served with the Davis' Co. of the 105th Militia

John Perregin

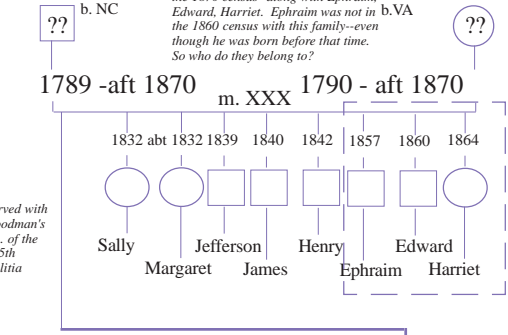

Served with Goodman's Co. of the 105th Militia

Charity Gross

Daniel Whittaker

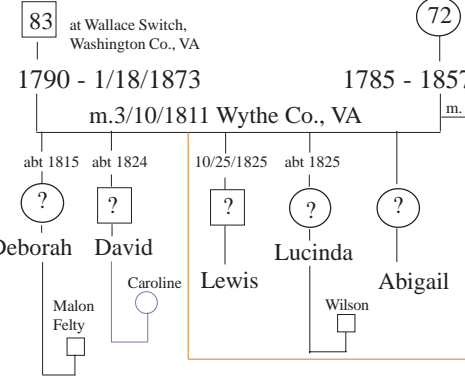

Served as a private in the company commanded by Samuel Grahams in the... in the War of 1812... received honorable discharge. Daniel had a farm in Washington Co.

Camilla Ann Adkins

Married in Blountville, Sullivan Co, Tennessee by a Baptist minister in the home of William Gammon. Camilla was the widow of Aaron B. Parker of Botetourt, VA 1814- 9/22/ 1854.

John Held (Helt)

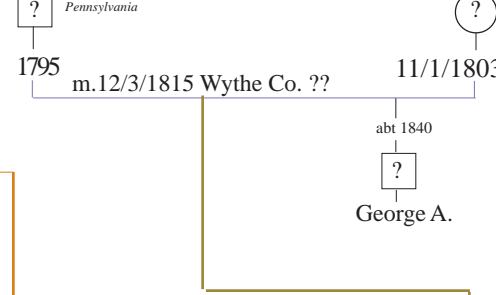

William A. Blalock

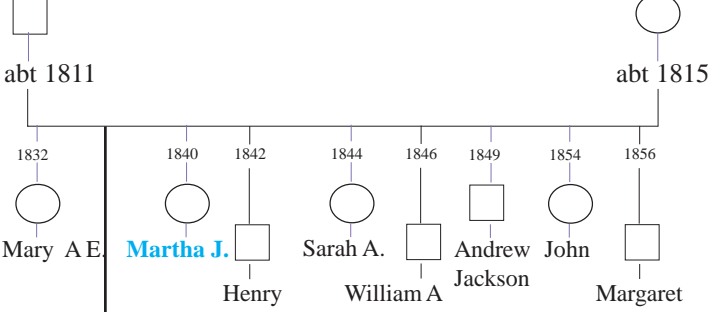

1850 District 7, Grainger, Tennessee Census
1850 District 7, Grainger, TN Census - Page 2
1870 Scott County, Estillville, VA Census
1880 Scott County, Johnson District, VACensus

William Canter

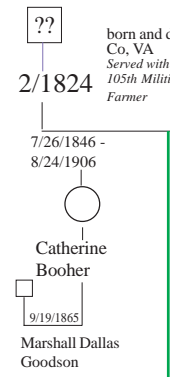

Elizabeth Mary Perregin

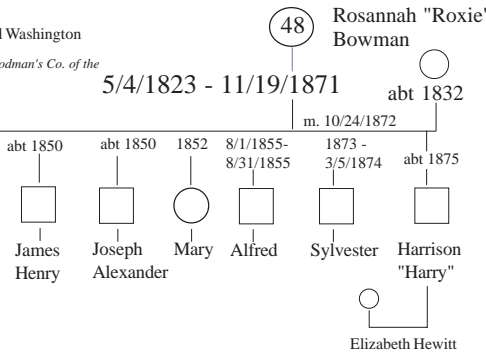

Calvin Whittaker

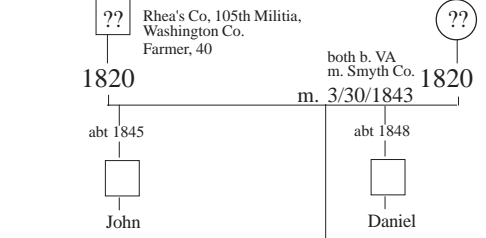

Phoebe Held (Helt)

After her husband died, she went back to live with her parents. Samuel once told Mary Blaylock, his son's wife, that his mother looked just like a picture on a calendar, she was so beautiful.
-- Mary Hutton Blaylock

XXXXXXX

Catherine Blaylock

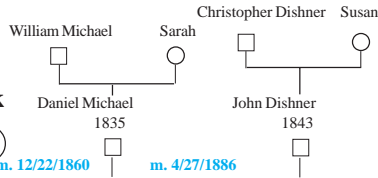

abt 1838

"Virginia, Births and Christenings, 1853-1917"

Name: Samuel P. Blaylock Gender: Male
Birth Date: 21 Oct 1856
Birthplace: Greasy Valley, Scott, Virginia
Father's Name:
Father's Birthplace:
Father's Age:
Mother's Name: Catharine Blaylock
Mother's Birthplace:
Mother's Age:
Indexing Project (Batch) Number: C01315-8
System Origin: Virginia-EASy GS Film number: 2046966 Reference ID: p 31



According to Mary Blaylock, widow of Arthur's younger brother, Orville, Sam lived with her and her husband for 9 years before he died. Sam said his father came from Ireland during the potato famine of the 1840s and was living in Kentucky, working on the railroad. Sam's father was killed in an accident when Sam was 4-years-old. His mother, Catherine, moved back home, and his grandmother helped raise him. --jk

William Harmon "Dock" Canter

57 born and died Washington Co, VA shoemaker by trade

1847 - 2/20/1904

Mary Ann Whittaker

buried Cleanbranch Cemetery, Washington Co, VA

53

7/9/1847 - 11/03/1900

m 8/3/1867 Washington Co., VA

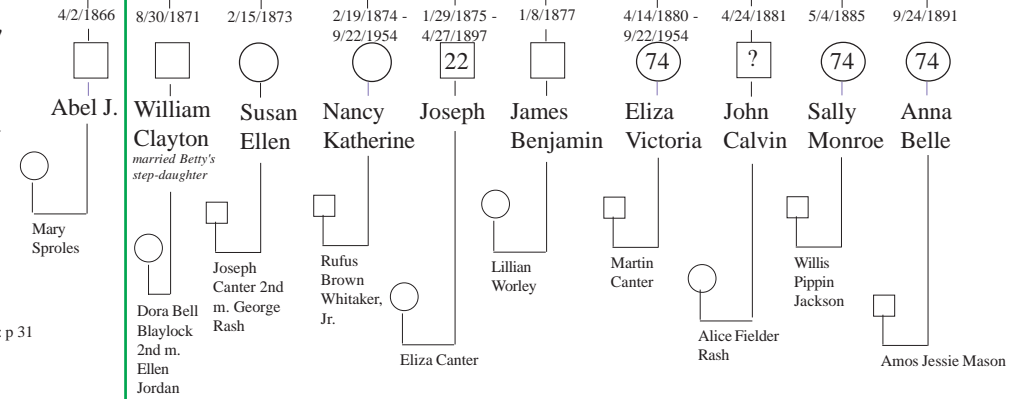

Samuel Patrick Blaylock

87 According to Arthur, his father, Sam, was from Scott County, Va.-- verified on marriage certificate

3/22/1850 - 7/10/1936

m. 7/26/1875

Mary Catherine Fleenor

m. 6/2/1887

Mary Elizabeth "Betty" Canter

58

12/6/1869 - 8/3/1927

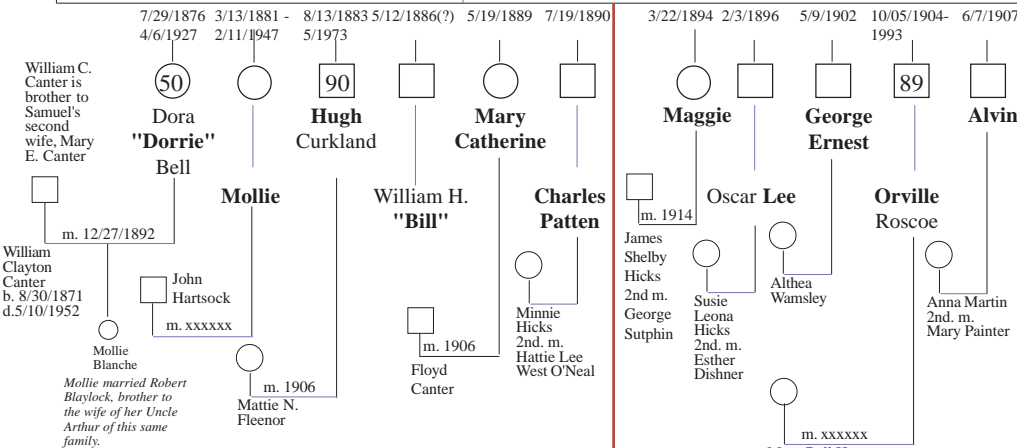

Samuel Patrick Blaylock and Mary Elizabeth "Betty" Canter Blaylock

Mary Bell Hutton b. 11/1/1909 had 3 sons: 2 preachers, 1 doctor

Generation 2

Generation 1

Arthur takes a break from work to have his picture made with daughter, Grace



William ARTHUR Blaylock was known as a very strong man, even though he had a slight stature. According to family legend, Arthur was paid a wage and a half when he worked for the railroad, because he could carry two railroad ties at one time. Another family story reports a time when a taxi cab had a flat tire on the road near his home and the driver had no tire jack in the car. So, Arthur held up the car while the driver changed the tire. Arthur was a very quiet man who died of old age. -- Judy Blaylock

William Arthur Blaylock

88

9/18/1892 - 12/27/1980

Pictured below: Barbra Ellen Felty Blaylock and young daughter, Anna Maude Blaylock.



Anna Maude Blaylock

77

8/27/1895 - 4/23/1973 died of throat cancer

m. 5/13/1913

Nancy "Nannie" Virginia Olsen George



Nannie never had children; heavy smoker; heart attack; took care of father and then Grace before they died

James "Jim" William



Alma



Dal Todd, Ray Mays

Danny, Betty Jo, Sonny

Edith, Charlotte, Dicky, Mary Frances, Junior, Becky

Ina Pauline "Polly" "Paula"



Shorty with Charlotte, Dicky, Edith and Becky



Francoise Marmaroli

passed away on January 21, 2015



During WWII, while in Marseilles, France, Herbert met and fell in love with Francoise Marmaroli. Francoise was pregnant with Herbert's daughter when Herbert was discharged and sent home to the States. Herbert obtained the necessary paperwork to have Francoise join him in the U.S. The facts surrounding the fact that Francoise never came to the United States are unknown to this genealogist. However, the lovely GISELE FRANCINE LOUISE MARMAROLI MARTIN has been found, or rather, her youngest son found us, her America family. We are so happy and excited to now have a relationship with our first sister.

Alvin, Alton

Clarence "Shorty" Emmanuel



Carl Blaylock served in WWII--injury collapsed one lung--later died of lung cancer



Beulah

1970--Herbert with first two grandchildren, Daren Hubers & Pam Howard



WWII vet; taken prisoner in France; dairyman; heavy smoker; congestive heart failure

Carl Henry

Herbert Eugene Blaylock



Grace Lee

Harley Olinger

Grace had lung cancer; heavy smoker



Woodrow Moore

Paul, Diane

Bonnie Ellen



Nellie Elizabeth Privette

10/19/1931

Privette Family Tree

6/3/1933

Donald Glenn



Dorcas Blackburn

5/12/1937 - 3/26/2012



Anna Katherine

Tommy Jackson, Fred Anders

Brenda, Rhonda, Freda

"Aunt Catharine was just an adolescent girl when I was born, and she used to come over and play with me a lot. Her brothers and sisters called her Cat, for short. One day, when I was about as lonely as a 2-year-old can get--or spoiled for attention as the case may be--I went to the door and called, 'Hey Aunt Kitty Cat', get me." As reported by my mother, Nellie Privette Blaylock J.B.K