

Genealogy of Anna Maude Blaylock

daughter of
Joseph M. Blaylock
and Barbra Ellen Felty Blaylock

wife of
William Arthur Blaylock
who is the son of
Samuel Patrick Blaylock
and Mary Elizabeth "Bettie" Canter

Maude's favorite color: lavender

Favorite activities: gardening, needlework -- quilting, crocheting and embroidery

Favorite flowers: dahlias, touch-me-nots, geraniums, roses, moss roses, hollyhocks, gladiolas

Reputation: good cook

Allergies: strawberries

Medical history: Anna Maude had cancer in her left jaw when she was in her 30s.

Surgery was successful. Maude died of throat cancer when she was 77 years old.

**The best way to view this family tree -- which is in genogram format --
is to go to the bottom of the file and scroll up -- the way a tree grows.**

Primary researchers, Gail Blaylock Garrett and Judy Blaylock Kilpatrick, make every effort to verify data through as many sources as possible.

Click on blue hyperlinks to view documents or additional information or photographs.

Unless a document is attached for verification, information is based upon interview and oral or written history.

Peter Bucher

Unknown

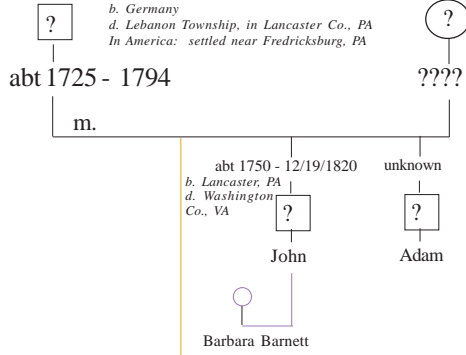

Speculation: John A. M. Booher is the son of Michael Booher and Mary Houser. *Basis for speculation:* Martin Booher Sr. had 7 sons. Of those 7 sons, to the older 5 of them, he bequeathed in his will land holdings in the Sullivan County, Tennessee area. To the youngest son he bequeathed a monetary inheritance. To the other two sons, Samuel and Michael, Martin bequeathed land in Scott Co, VA. From the census records, we find that Samuel and his wife Mary lived in Scott Co., where Samuel died at a young age. Mary and her children continued to live in Scott Co., as evidenced by census records of 1850 and 1860. Michael, on the other hand, sold his land holdings and moved to Robertson, TN. Michael and his wife Mary can be followed through census records for several decades, still living in Robertson, TN. In Estillville, Scott Co., VA, we find in 1860 a son of Samuel, John A. and his wife, Sarah C. Sproles, and family. We also find, in close proximity, John A. M. and his wife, Sarah, and family. The only piece of evidence that would cast doubt on the assumption that John A.M. is the son of Michael is the census of 1860, because a John of the appropriate age is in the household of Michael and Mary in Robertson, TN during that same census year. A plausible explanation does exist, however. The census in Estillville, Scott Co., VA was taken in June. The census in Robertson, TN was taken in October. There is a possibility that John was visiting his parents, perhaps to help with harvest, when the census taker arrived at their home. At this time, I can find no other reasonable explanation for the identify of John A.M. and the John in the home of Michael and Mary in TN in 1860.

Christian Hartmann

Unknown

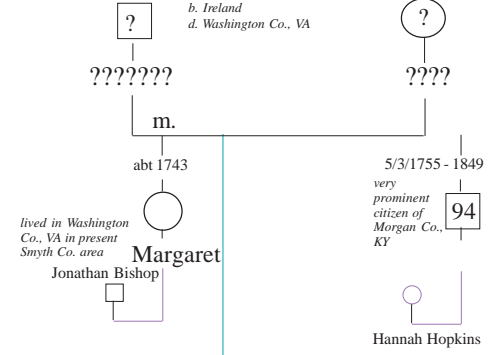

DNA Project Additional Info

Baptism: 18/17/1746, Jonestown: Swatara Reformed Congregation, Lebanon County, Pennsylvania, USA

Martin Booher

8/1/1746 - 10/1824
 m. January 1774 in Lancaster: Trinity Lutheran Church, Lancaster County, PA
 b. Hanover Township, Lancaster Co, PA
 baptized: 8/17/1746 Swatara Lutheran Church
 sponsors: George Meyer
 d. Sullivan Co, TN

The marriage notes in the church record book: "Martin, Peter Bucher's legitimate son, Hanover township, and Catharine, Christian Hartmann's legitiimate daughter, in Manheim Township, both single."

Catharina Hartmann

1760 - 2/25/1834
 b. Warwick, PA

- 1. Jerry H. Barrett, Lansing IL
- 2. Martin Booher will
- 3. 1820 Scott Co. VA census
- 4. 1840 McMinn TN census
- 5. 1850 Robertson Co. TN census
- 6. 1860 Robertson Co. TN census
- 7. Booher, Allen G. sr. MY OFTEN MISSPELLED NAME IS BOOHER

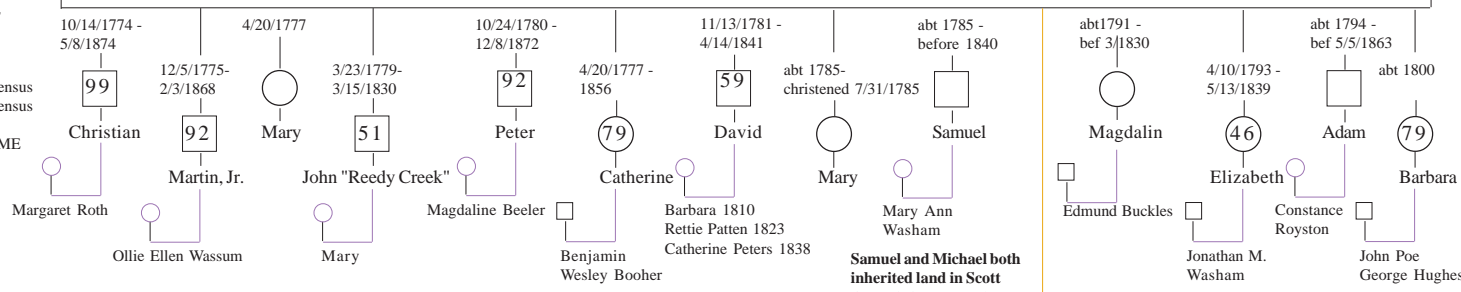

Martin willed Barbara \$1248.00 provided " she don't never take up with John Poe; if she ever takes up with him again, it is my desire for her to have one dollar and no more—to be paid one half two years after my death, the balance in four years."

Nicholas Velte

Elizabeth

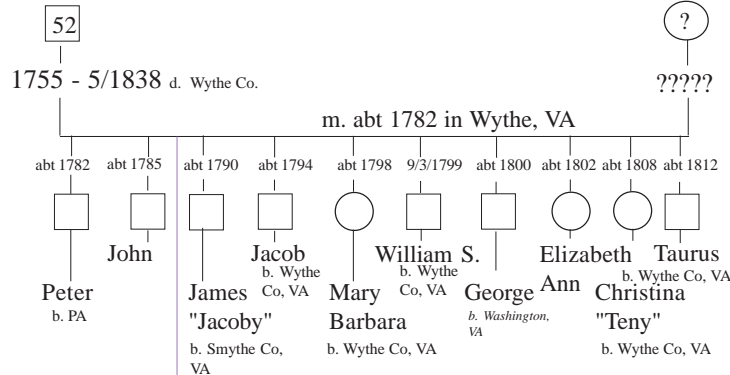



Reuben Blaylock

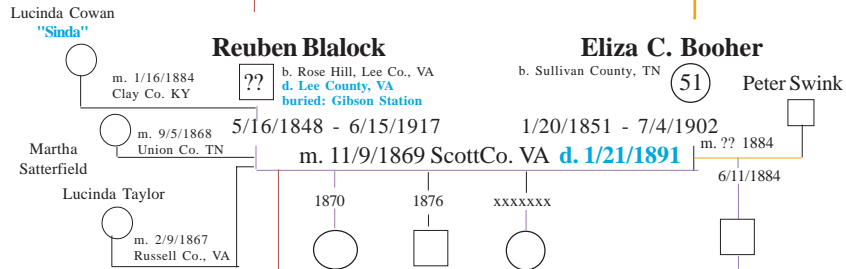

Tennessee, Marriages, 1851-1900
 about Reuben D. Blalock
 Name: Reuben D. Blalock
 Gender: Male
 Spouse: Martha Satterfield
 Spouse Gender: Female
 Marriage Date: 5 Sep 1868
 County: Union
 State: Tennessee

Confederate Pension Application

1860 Grainger, TN Census
 1940 Sindyay Braylock

Sarah E. **John F.** **Margaret**
T.J. Harr

1920 Wise Co. VA Census
Census Records: 1880, 1920 1910



Back Row:
 Anna Maude Blaylock,
 Barbara Ellen Felty Blaylock,
 Sarah "Sally" Felty
Front Row:
 Marion Wesley Blaylock,
 Barbara Margaret Tranbarger Felty,
 Daniel Felty,
 Unknown baby

1850 Washington Co., VA Census
 1860 Washington Co., VA Census
 1860 Washington Co., VA Census -- Pg 2
 1870 Washington Co., VA Census
 1880 Washington Co., VA Census

Daniel is the son of Malon Felty and Deborah Whittaker Daniel Felty

Margaret is living with Joseph Blaylock and Ellen in 1900 and 1910 census. Margaret's youngest son, Flemen, is also living with this family.

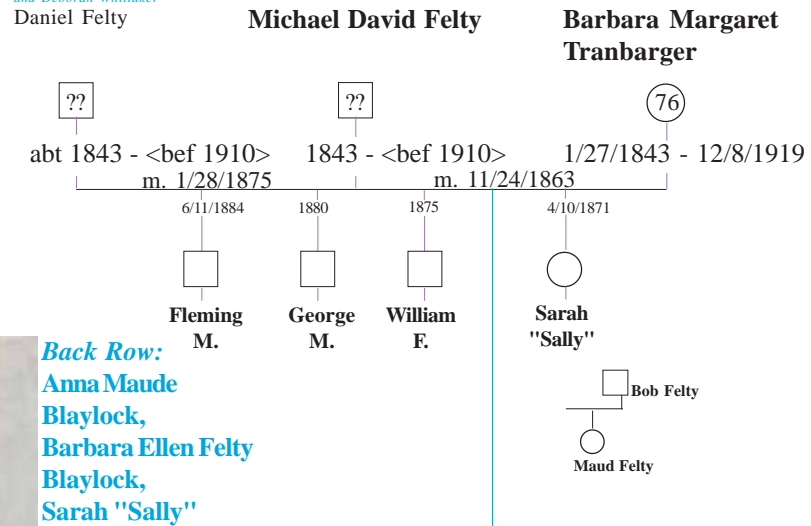

Right: Barbra Ellen Felty Blaylock with daughter Anna Maude Blaylock



Family Photos of Joe Blaylock and Barbra Ellen and their Children



Joseph M. Blaylock

born in Russell Co, VA

3/20/ 1871 - 8/19/1947

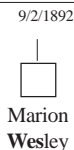

Marion WESley, William ROBERT, Joe Blaylock, Farris OLiver, Anna MAUDE

m. 3/17/1891

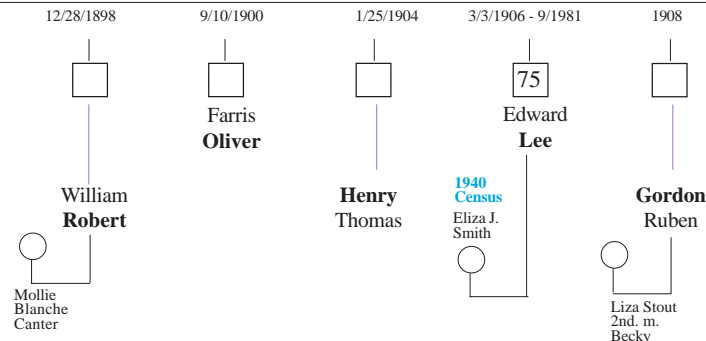

Generation 2

Generation 1

just died of old age; very quiet man; very strong

William Arthur Blaylock

88

9/18/1892 - 12/27/1980

Arthur takes a break from work to have his picture made with daughter, Grace



m. 5/13/1913

2/26/1914 - 4/6/1991

74

James "Jim" William



Nancy Olsen George "Nannie" Virginia



Nannie never had children; heavy smoker; heart attack; took care of father and then Grace before they died

5/13/1916 - 10/6/1970

54

Ina Pauline "Polly" "Paula"



Dal Todd Ray Mays

Danny Betty Jo Paul Nyoka Sonny

9/9/1922 - 7/27/2003

79

5/10/1926

Alvin Alton



Shorty with Charlotte, Dicky, Edith and Becky

6/5/1919 - 8/31/1997

78

Clarence "Shorty" Emmanuel



Carl Blaylock served in WWII--injury collapsed one lung--later died of lung cancer

Francoise Marmaroli Francoise Marmaroli passed away on January 21, 2015



During WWII while in Marseilles, France, Herbert met and fell in love with Francoise Marmaroli. Francoise was pregnant with Herbert's daughter when Herbert was discharged and sent home to the States. Herbert obtained the necessary paperwork to have Francoise join him in the U.S. The facts surrounding the fact that Francoise never came to the United States are unknown to this genealogist. However, the lovely Gisele Francine Louise Marmaroli Martin has been found, or rather, her youngest son found us, her America family. We are so happy and excited to now have a relationship with our first sister.

6/7/1923 - 4/1963

39

Carl Henry



2/28/25 - 1/17/90

64

Herbert Eugene Blaylock



Beulah

1970--Herbert with first two grandchildren, Daren Hubers & Pam Howard



WWII vet; taken prisoner in France; dairyman; heavy smoker; congestive heart failure

10/25/1927 - 6/19/1990

63

Grace Lee



Grace had lung cancer; heavy smoker

12/10/1929

Bonnie Ellen



Harley Olinger

Woodrow Moore Paul Diane

6/3/1933

Donald Glenn



Dorcas Blackburn

Nellie Elizabeth Privette



10/19/1931

Privette Family Tree

Pictured below: Barbra Ellen Felty Blaylock and young daughter, Anna Maude Blaylock.



Anna Maude Blaylock

77

8/27/1895 - 4/23/1973 died of throat cancer

5/12/1937 - 3/26/2012

Anna Katherine



Tommy Jackson Fred Anders Brenda Rhonda Freda

"Aunt Catharine was just an adolescent girl when I was born, and she used to come over and play with me a lot. Her brothers and sisters called her Cat, for short. One day, when I was about as lonely as a 2-year-old can get--or spoiled for attention as the case may be--I went to the door and called, 'Hey Aunt Kitty Cat', get me." As reported by my mother, Nellie Privette Blaylock J.B.K